 Health Canada / Santé Canada	Title of publication-Titre de la publication Product Safety Laboratory Reference Manual Book 5 - Laboratory Policies and Procedures	Page F16-1	Effective En vigueur 2001-04-24
Chapter and/or Section;-Number and title-Chapitre ou section-Numéro et titre Part B: Test Methods Section, Method F-16 TEST METHOD FOR THE FLAME RESISTANCE OF TENTS			Amendment number- Numéro de la modification 26

1 SCOPE

- 1.1 This method describes procedures for evaluating the flammability of tents including camping tents, play tents, ice-fishing tents and dining shelters but not including canopies, awnings, tarpaulins, tent trailers, air-supported structures or tents subject to the *National Building Code of Canada, 1985*. It is applicable to item 31.1 of Part II of Schedule I of the Hazardous Products Act (HPA).
- 1.2 This method is provided to facilitate laboratory procedures only. It is the trader's responsibility to ensure that the product is tested according to, and meets the requirements of the HPA and its Regulations.

2 APPLICABLE DOCUMENTS

- 2.1 Hazardous Products (Tents) Regulations SOR 90-245 ([Appendix I](#))
- 2.2 Industrial Fabrics Association International Standard: CPAI-84, 1980 *A Specification for Flame Resistant Materials used in Camping Tentage*, ([Appendix II](#) - referenced sections only)
- 2.3 Product Safety Reference Manual: *Book 4 - Flammable Products*
- 2.4 Product Safety Laboratory Project #99-0544 - Tents Test Method Review

3 DEFINITIONS

- 3.1 See section 2 of the Hazardous Products (Tents) Regulations ([Appendix I](#))
- 3.2 *Flaming residue*: portions of the specimen that break off or residues that drip from the specimen and that continue to flame after reaching the floor of the test cabinet.

4 APPARATUS

- 4.1 See sections 5.2.2 (leaching), 6.2 (flooring materials) and 7.2 (wall and top materials) of CPAI 84. ([Appendix II](#))

5 PROCEDURE

Note: The Product Safety Laboratory does not test in accordance with the accelerated weathering requirements.

 Health Canada / Santé Canada	Title of publication-Titre de la publication Product Safety Laboratory Reference Manual Book 5 - Laboratory Policies and Procedures	Page F16-2	Effective En vigueur 2001-04-24
Chapter and/or Section;-Number and title-Chapitre ou section-Numéro et titre Part B: Test Methods Section, Method F-16 TEST METHOD FOR THE FLAME RESISTANCE OF TENTS			Amendment number- Numéro de la modification 26

- 5.1 Remove, copy or take notes from any label or other information that accompanies the sample
- 5.2 Verify that the labels and warning statements meet the requirements of section 4 of the Hazardous Products (Tents) Regulations ([Appendix I](#)).
- 5.3 Cut and condition¹ specimens of the flooring material and the wall and top material as per sections 2 and 3 respectively of Schedule II of the Hazardous Products (Tents) Regulations ([Appendix I](#)). Disregard references to the accelerated weathering requirements. Only two sample units from each material are required. **Note:** The flooring material is tested use-side up - mark a corner of each specimen with indelible ink on the use-side immediately after cutting.
- 5.4 Test the flooring material as per section 2 of Schedule II of the Hazardous Products (Tents) Regulations ([Appendix I](#)) and the referenced sections of CPAI 84 ([Appendix II](#)). Disregard references to the accelerated weathering requirements.
- 5.5 Test the wall and top material as per section 3 of Schedule II of the Hazardous Products (Tents) Regulations ([Appendix I](#)) and the referenced sections of CPAI 84 ([Appendix II](#)). Disregard references to the accelerated weathering requirements. **Note:** The requirement concerning flaming residue is required by the Regulations but not by CPAI 84.

6 HEALTH AND SAFETY

- 6.1 The fumehood should be set to low during both of the tests.
- 6.2 After the wall and top test is completed, turn the fumehood to high and open the test chamber door slowly and only about 10 cm in order to evacuate the smoke.
- 6.3 The specimen holders will be hot - either allow them to cool in place or wear heat resistant gloves to remove them.

7 QUALITY ASSURANCE/QUALITY CONTROL PROCEDURES

- 7.1 The frames should be properly aligned inside the flammability cabinet.
- 7.2 The flame must be adjusted to the specified height before testing.

¹ It may be sufficient in routine testing to expose the material to the standard atmosphere for at least 12 hours prior to testing. For official samples or in cases of dispute, moisture equilibrium shall be obtained using the method described in paragraph 5.1.2 of CPAI 84

 Health Canada Santé Canada	Title of publication-Titre de la publication Product Safety Laboratory Reference Manual Book 5 - Laboratory Policies and Procedures	Page F16-3	Effective En vigueur 2001-04-24
Chapter and/or Section;-Number and title-Chapitre ou section-Numéro et titre Part B: Test Methods Section, Method F-16 TEST METHOD FOR THE FLAME RESISTANCE OF TENTS			Amendment number- Numéro de la modification 26

- 7.3 The methane should be at least 97% pure.
- 7.4 The desiccant used must be anhydrous. This can be ensured by using a desiccant with a colour indicator.
- 7.5 The stopwatch must be capable of measuring the burn time to 0.2s and should be calibrated on a regular basis.
- 7.6 The mass of the weights (loads) shall be verified using a calibrated balance.
- 7.7 The scale or ruler must be graduated in millimetres.
- 7.8 There are no Quality Control procedures for this method at this time.

8 TEST REPORT

- 8.1 The test report should contain the following information:
 - 8.1.1 The fibre content, if given (analysis not required).
 - 8.1.2 Whether the labelling meets the requirements of section 4 of the Hazardous Products (Tents) Regulations (scan the label if possible).
 - 8.1.3 Test results on the flooring material 'as-received' and after leaching, for each specimen.
 - 8.1.4 Test results for the wall and top material 'as-received and after leaching, for each specimen plus average after-flame time, average damaged length and average fabric mass.
 - 8.1.5 Scanned copy of all labels, where possible.
- 8.2 The report will be prepared in the format illustrated below:

Fibre content (from label): wall and top: 100% polyester
 flooring: 100% nylon



Chapter and/or Section;-Number and title-Chapitre ou section-Numéro et titre

Part B: Test Methods Section, Method F-16
TEST METHOD FOR THE FLAME RESISTANCE OF TENTS

Amendment
number-
Numéro de la
modification

26

Wall and Top Material

Average fabric mass = 87 g/m²

As received

Specimen	Direction of Test	After-flame Time (s)	Char Length (mm)	Flaming Residue
1	lengthwise	0	156	no
2	lengthwise	0	179	no
3	lengthwise	0	250	yes
4	lengthwise	0	245	no
5	crosswise	0	182	no
6	crosswise	13.2	201	no
7	crosswise	0	214	no
8	crosswise	6.6	254	no
Average		2.5 s	210 mm	

After leaching

Specimen	Direction of Test	After-flame Time (s)	Damaged Length (mm)	Flaming Residue
1	lengthwise	0	81	no
2	lengthwise	0	193	no
3	lengthwise	0	67	no
4	lengthwise	0	121	no
5	crosswise	13.2	113	yes
6	crosswise	0	119	no
7	crosswise	6.6	121	no
8	crosswise	0	158	no
Average		3.5 s	122 mm	

 Health Canada / Santé Canada	Title of publication-Titre de la publication Product Safety Laboratory Reference Manual Book 5 - Laboratory Policies and Procedures	Page F16-5	Effective En vigueur 2001-04-24
Chapter and/or Section;-Number and title-Chapitre ou section-Numéro et titre Part B: Test Methods Section, Method F-16 TEST METHOD FOR THE FLAME RESISTANCE OF TENTS			Amendment number- Numéro de la modification 26

Flooring Material

As Received

Specimen #	Closest distance to inside edge of ring (mm)
1	90
2	77
3	83
4	86

After Leaching

Specimen #	Closest distance to inside edge of ring (mm)
1	90
2	50
3	89
4	67

[Scan of label] (not to scale)

Letter height of warning statement: 2.8 mm

- 8.3** Attach sample swatches to the report identifying on each swatch from which part of the tent it comes.

9 PRECISION AND BIAS

- 9.1 Precision - No statement concerning precision can be made at this time.

 Health Canada / Santé Canada	Title of publication-Titre de la publication Product Safety Laboratory Reference Manual Book 5 - Laboratory Policies and Procedures	Page F16-6	Effective En vigueur 2001-04-24
Chapter and/or Section;-Number and title-Chapitre ou section-Numéro et titre Part B: Test Methods Section, Method F-16 TEST METHOD FOR THE FLAME RESISTANCE OF TENTS			Amendment number- Numéro de la modification 26

9.2 Bias -Since the true values of flammability samples are not known, bias cannot be determined.

10 SAMPLING

10.1 One sample is usually sufficient. In the case of small play tents, two may be required. The area and shape of flooring material will probably be the determining factor as 2 sample units, each consisting of 4, 230 x 230 mm specimens, are required and the specimens in each sample unit cannot the same lengthwise or crosswise fibres or filaments.

 Health Canada / Santé Canada	Title of publication-Titre de la publication Product Safety Laboratory Reference Manual Book 5 - Laboratory Policies and Procedures	Page F16-7	Effective En vigueur 2001-04-24
Chapter and/or Section;-Number and title-Chapitre ou section-Numéro et titre Part B: Test Methods Section, Method F-16 TEST METHOD FOR THE FLAME RESISTANCE OF TENTS			Amendment number- Numéro de la modification 26

APPENDIX I

Hazardous Products (Tents) Regulations ²

SOR/88-114, P.C. 1988-131
21 January, 1988

amended by

SOR/90-245 P.C. 1990-738

His Excellency the Governor General in Council, on the recommendation of the Minister of Consumer and Corporate Affairs, pursuant to section 5* of the Hazardous Products Act, is pleased hereby to revoke the Hazardous Products (Tents) Regulations, made by Order in Council P.C. 1988-131 of January 21, 1988**, and to make the annexed Regulations respecting the advertising, sale and importation of tents, in substitution therefor.

* R.S., c. 24 (3rd Supp.), s. 1

** SOR/88-114, 1988 Canada Gazette Part II, p. 1072

REGULATIONS RESPECTING THE ADVERTISING, SALE AND IMPORTATION OF TENTS

Short Title

1. These Regulations may be cited as the Hazardous Products (Tents) Regulations.

Interpretation

2. In these Regulations,

"after-flame time" means the length of time a wall and top material tested in accordance with the procedure set out in section 7 of CPAI-84 continues to flame after the ignition source has been removed; (durée de combustion résiduelle)

"CPAI-84" means A Specification for Flame Resistant Materials used in Camping Tentage, being specification CPAI-84, 1980, established by the Industrial Fabrics Association International (formerly the Canvas Products Association International), published in 1980; (norme CPAI-84)

² This consolidation is prepared for convenience only. For all purposes of interpreting and applying the law, users should consult the regulations, as registered by the Clerk of the Privy Council and published in Part II of the Canada Gazette.

 Health Canada / Santé Canada	Title of publication-Titre de la publication Product Safety Laboratory Reference Manual Book 5 - Laboratory Policies and Procedures	Page F16-8	Effective En vigueur 2001-04-24
Chapter and/or Section;-Number and title-Chapitre ou section-Numéro et titre Part B: Test Methods Section, Method F-16 TEST METHOD FOR THE FLAME RESISTANCE OF TENTS			Amendment number- Numéro de la modification 26

"flooring material", with respect to a product, means the fabric or other pliable material that constitutes the floor of the product; (matériau de sol)

"product" means a tent that is included in item 31.1 of Part II of Schedule I to the Hazardous Products Act; (produit)

"sample unit" means

(a) in respect of flooring material, four specimens of the material that meet the requirements referred to in paragraphs 2(a) and (b) of Schedule II, and

(b) in respect of wall and top material, eight specimens of the material that meet the requirements referred to in paragraphs 3(a) and (b) of Schedule II; (unité d'échantillonnage)

"wall and top material", with respect to a product, means the fabric or other pliable material that constitutes a wall, roof, top, door, window, screen or awning of the product. (matériau pour murs et toits)

General

3. A person may advertise, sell or import a product if the information requirements set out in section 4 and the performance requirements set out in sections 5 and 6 are met.

Information requirements

4. A product shall have a label that is permanently affixed to the product at a prominent location and that displays in a legible manner in both official languages

(a) the following statement in upper-case letters not less than 3 mm in height:

"WARNING: KEEP ALL FLAME AND HEAT SOURCES AWAY FROM THIS TENT FABRIC/MISE EN GARDE : TENIR LE TISSU DE CETTE TENTE LOIN DE TOUTE FLAMME ET DE TOUTE SOURCE DE CHALEUR";

(b) the following statement:

"This tent is made of flame-resistant fabric. It is not fireproof. The fabric will burn if left in continuous contact with a flame source./Cette tente est fabriquée d'un tissu résistant au feu, mais qui n'est pas ininflammable. Ce tissu brûlera s'il est laissé en contact continu avec une source d'inflammation."; and

(c) the information set out in Schedule I, in the words used in that schedule or in other words that convey the same meaning.

Performance requirements

 Health Canada / Santé Canada	Title of publication-Titre de la publication Product Safety Laboratory Reference Manual Book 5 - Laboratory Policies and Procedures	Page F16-9	Effective / En vigueur 2001-04-24
Chapter and/or Section;-Number and title-Chapitre ou section-Numéro et titre Part B: Test Methods Section, Method F-16 TEST METHOD FOR THE FLAME RESISTANCE OF TENTS			Amendment number- Numéro de la modification 26

5. When a sample unit of flooring material of a product is prepared and tested in accordance with the procedures set out in Schedule II, no specimen of the sample unit shall display any damage within 25 mm of the edge of the hole in the flattening frame.

6. When a sample unit of wall and top material of a product is prepared and tested in accordance with the procedures set out in Schedule II,

(a) no specimen of the sample unit shall have an after-flame time that exceeds four seconds and the average after-flame time of the specimens of the sample unit shall not exceed two seconds;

(b) the maximum damaged length of each specimen of the sample unit and the maximum average damaged length of the specimens of the sample unit shall be as follows:

Mass per Unit Area of Specimen Being Tested (g/m ²)	Maximum Damaged Length of Each Specimen of the Sample Unit (mm)	Maximum Average Damaged Length of Each Specimen of the Sample Unit (mm)
greater than 340	255	115
271 to 340	255	140
201 to 270	255	165
136 to 200	255	190
51 to 135	255	215
less than 51	255	230

(c) no specimen of the sample unit shall have portions that break, or residues that drip, from the specimen and that continue to flame after reaching the floor of the test cabinet.

SCHEDULE I
(Section 4)

INFORMATION

1. The following precautions should be taken when camping:

(a) do not use candles, matches or open flames of any kind in or near a tent;

 Health Canada / Santé Canada	Title of publication-Titre de la publication Product Safety Laboratory Reference Manual Book 5 - Laboratory Policies and Procedures	Page F16-10	Effective En vigueur 2001-04-24
Chapter and/or Section;-Number and title-Chapitre ou section-Numéro et titre Part B: Test Methods Section, Method F-16 TEST METHOD FOR THE FLAME RESISTANCE OF TENTS			Amendment number- Numéro de la modification 26

- (b) do not cook inside a tent;
- (c) build campfires downwind and several metres away from a tent and be sure to fully extinguish campfires before leaving a campsite or before retiring for the night;
- (d) exercise extreme caution when using fuel-powered lanterns or heaters inside a tent and use battery-operated lanterns whenever possible;
- (e) do not refuel lamps, heaters or stoves inside a tent;
- (f) extinguish or turn off all lanterns before going to sleep;
- (g) do not smoke in a tent; and
- (h) do not store flammable liquids inside a tent.

SCHEDULE II
(Sections 2, 5 and 6)

PROCEDURES FOR TESTING TENTS

General

1. A flame test of a specimen shall be performed
 - (a) under the standard atmospheric conditions specified in subsection 5.1.1 of CPAI-84, or immediately upon the removal of the specimen from such conditions; and
 - (b) when the specimen is in moisture equilibrium, within the meaning of subsection 5.1.2 of CPAI-84.

Test of Flooring Material

2. The method to be followed in measuring the damage displayed by specimens of a sample unit of flooring material is as follows:
 - (a) from the flooring material of the product to be tested, cut 12 specimens that meet the requirements set out in subsection 6.1 of CPAI-84;
 - (b) divide the specimens into three sample units, ensuring that, where the flooring material is woven, none of the specimens within a sample unit contains the same warp, weft yarns or filaments as any other specimen in that sample unit;

 Health Canada / Santé Canada	Title of publication-Titre de la publication Product Safety Laboratory Reference Manual Book 5 - Laboratory Policies and Procedures	Page F16-11	Effective En vigueur 2001-04-24
Chapter and/or Section;-Number and title-Chapitre ou section-Numéro et titre Part B: Test Methods Section, Method F-16 TEST METHOD FOR THE FLAME RESISTANCE OF TENTS			Amendment number-Numéro de la modification 26

(c) prepare one sample unit in accordance with the leaching requirements set out in subsections 5.2.2 and 5.2.3 of CPAI-84;

(d) prepare a second sample unit in accordance with the accelerated weathering requirements set out in subsections 5.3.2 and 5.3.3 of CPAI-84;

(e) test the three sample units in accordance with the flame test method set out in section 6 of CPAI-84; and

(f) record, for each specimen, the shortest distance between the damaged area and the edge of the hole in the flattening frame.

Test of Wall and Top Material

3. The method to be followed in measuring the after-flame time, the average after-flame time, the damaged length and the average damage length of specimens of a sample unit of wall and top material is as follows:

(a) from the wall and top material of the product to be tested, cut 24 specimens that meet the requirements for test specimens set out in subsection 7.1 of CPAI-84;

(b) divide the specimens into three sample units, ensuring that, where the wall and top material is woven, each sample unit contains four specimens from the warp direction and four specimens from the weft direction of the wall and top material and that none of the specimens from the warp direction contains the same warp yarns or filaments as any other specimen from the warp direction and none of the specimens from the weft direction contains the same weft yarns or filaments as any other specimen from the weft direction;

(c) condition the specimens according to the procedures set out in subsections 5.1.1 and 5.1.2 of CPAI-84;

(d) determine the mass per unit area of the specimens to the nearest g/m²;

(e) prepare one sample unit in accordance with the leaching requirements set out in subsections 5.2.2 and 5.2.3 of CPAI-84;

(f) prepare a second sample unit in accordance with the accelerated weathering requirements set out in subsections 5.3.2 and 5.3.3 of CPAI-84;

(g) test the three sample units in accordance with the flame test method set out in section 7 of CPAI-84, except that the loads for determining the damaged length set out in subsection 7.3.6.1 of CPAI-84 shall be replaced by the following:

 Health Canada / Santé Canada	Title of publication-Titre de la publication Product Safety Laboratory Reference Manual Book 5 - Laboratory Policies and Procedures	Page F16-12	Effective En vigueur 2001-04-24
Chapter and/or Section;-Number and title-Chapitre ou section-Numéro et titre Part B: Test Methods Section, Method F-16 TEST METHOD FOR THE FLAME RESISTANCE OF TENTS			Amendment number- Numéro de la modification 26

Mass per Unit area of Specimens Being Tested (g/m ²)	Loads for Determining Damaged Length (g)
100 or less	50
101 to 200	100
201 to 340	200
greater than 340	300

(h) record

- (i) the after-flame time of each specimen,
- (ii) the average after-flame time of the specimens of each sample unit,
- (iii) the damaged length of each specimen,
- (iv) the average damaged length of the specimens of each sample unit, and
- (v) the presence of any portions that break, or any residues that drip, from a specimen and that continue to flame after reaching the floor of the test cabinet.

 Health Santé Canada Canada	Title of publication-Titre de la publication Product Safety Laboratory Reference Manual Book 5 - Laboratory Policies and Procedures	Page F16-13	Effective En vigueur 2001-04-24
Chapter and/or Section;-Number and title-Chapitre ou section-Numéro et titre Part B: Test Methods Section, Method F-16 TEST METHOD FOR THE FLAME RESISTANCE OF TENTS			Amendment number- Numéro de la modification 26

APPENDIX II

Industrial Fabrics Association International (IFAI) Standard: CPAI 84, 1980

Only those sections of CPAI 84 that are referenced by the Regulations are reproduced here.

5. Conditioning

5.1 Standard Conditions for Testing. Flame tests shall be performed under or upon immediate removal from Standard Atmospheric Conditions and on specimens in moisture equilibrium under Standard Atmospheric Conditions.

5.1.1 Standard Atmospheric Conditions. Standard Atmospheric Conditions for testing are 65 percent \pm 2 percent relative humidity at a temperature of 70°F. \pm 2°F. (21.1°C \pm 1.1°C.)

5.1.2 Moisture Equilibrium. Moisture equilibrium is considered to have been reached when, after free exposure of the material to air in motion controlled at Standard Atmospheric Conditions as defined above, the change in weight of successive weighings made at intervals of 1 hour is no greater than 0.25 percent.

5.1.3 Preconditioning. In the event of dispute concerning the results of tests that may be affected by the moisture content, the material shall be preconditioned by being brought to moisture equilibrium with an atmosphere having a relative humidity of not over 10 percent and a temperature not over 125°F. (52°C.). The material shall then be brought to moisture equilibrium under Standard Atmospheric Conditions as defined above and then tested.

5.2 Leaching. Tests in Sections 6 and 7 shall be performed both before and after leaching.

5.2.1 Test Specimen. Test specimens to be leached shall be of the following dimension:

5.2.1.1 Flooring Material. Each test specimen shall be a 9 inch by 9 inch (\pm 1/16 inch) section of the flooring material to be tested.

5.2.1.2 Wall and Top Material. Test specimens shall be rectangles of cloth 2 3/4 inches by 12 inches (\pm 1/16 inch) with the long dimensions parallel to either the warp or filling directions of the material.

5.2.2 Apparatus

5.2.2.1 Water container or tank of such shape and size that the specimen can be submerged therein with all surfaces of the specimen having full access to the water. For cloth specimens the container shall allow not less than 1/2 gallon of water for each square foot of specimen. The water shall be changed by a continuous flow or by emptying and refilling so that there shall be at least six complete changes of water in a 72-hour period.

5.2.2.2 Means of maintaining water at a temperature of 60°F. to 70°F. (15.5°C. to 21.1°C.) and a pH of 6.0 to 8.0 during the test.

5.2.2.3 Means for holding the specimen submerged throughout the leaching period.

5.2.3 Procedure. The specimens shall be immersed in water at a temperature of 60°F. to 70°F. (15.5°C. to 21.1°C.) and a pH of 6.0 to 8.0 for 72 hours. The specimen shall then be removed, air-dried and brought to Standard Atmospheric Conditions prior to further testing.

5.3 Accelerated Weathering. Tests in Sections 6 and 7 shall be performed both before and after accelerated weathering.

5.3.1 Test Specimen. Test specimens to be weathered shall be of the following dimensions:

 Health Santé Canada Canada	Title of publication-Titre de la publication Product Safety Laboratory Reference Manual Book 5 - Laboratory Policies and Procedures	Page F16-14	Effective En vigueur 2001-04-24
Chapter and/or Section;-Number and title-Chapitre ou section-Numéro et titre Part B: Test Methods Section, Method F-16 TEST METHOD FOR THE FLAME RESISTANCE OF TENTS			Amendment number- Numéro de la modification 26

5.3.1.1 Flooring material. Each test specimen shall be a 9 inch by 9 inch ($\pm 1/16$ inch) section of the flooring material to be tested.

5.3.1.2 Wall and Top Material. Test specimens shall be rectangles of cloth 2 3/4 inches by 12 inches ($\pm 1/16$ inch) with the long dimensions parallel to either the warp or filling directions of the material.

5.3.2 Apparatus

5.3.2.1 Vertical carbon arc mounted at the center of a vertical cylinder. The arc shall be designed to accommodate either two or three pairs of carbons but shall burn only one pair at a time, automatically transferring from one pair to another as the carbons are consumed. The carbons shall be Sunshine-cored and copper-coated, No. 22 for the upper pair and No. 13 for the lower pair. The arc shall be operated on 60 amperes and 50 volts across the arc for alternating current and on 50 amperes and 60 volts across the arc for direct current.

5.3.2.2 A rotating rack with holder in which the specimens are suspended vertically and normally to radiation from the arc with the center of the face of the specimen at a radial distance of approximately 18 inches from the arc.

5.3.2.3 Water-spray nozzles shall be mounted horizontally (the water-spray assembly vertically) in the test chamber inside the specimen rack and so placed that the water shall strike the specimens evenly over their entire length in the form of a fine spray in sufficient volume to cover specimens immediately on impact. The apparatus shall be so operated that the specimens are exposed to successive cycles of 102 minutes of light without spray and 18 minutes of light with spray.

5.3.2.4 Means for maintaining the required temperature of water in the spray.

5.3.2.5 Means for maintaining the required pressure of water entering the spray.

5.3.2.6 Means for delivering the required quantity of water per spray nozzle to the specimen.

5.3.2.7 Exhaust fan to ventilate the arc effectively.

5.3.2.8 Black panel thermometer unit for measuring the temperature within the machine. This unit shall consist of a metal panel to the base of which is attached the sensitive portion of a bimetallic dial-type thermometer. The entire base is then coated twice with long lasting baked enamel paint.

5.3.3 Procedure

5.3.3.1 The rack shall rotate about the arc at a uniform speed of one revolution per minute.

5.3.3.2 The temperature of water in the spray shall be $80^{\circ} \pm 10^{\circ}\text{F}$ ($26.7^{\circ} \pm 5.6^{\circ}\text{C}$.)

5.3.3.3 The pressure of the water entering the spray shall be 1 - 18 psi inclusive.

5.3.3.4 The quantity of water delivered to the specimen shall be 12 to .25 gallons, inclusive, per hour per spray nozzle.

 Health Santé Canada Canada	Title of publication-Titre de la publication Product Safety Laboratory Reference Manual Book 5 - Laboratory Policies and Procedures	Page F16-15	Effective En vigueur 2001-04-24
Chapter and/or Section;-Number and title-Chapitre ou section-Numéro et titre Part B: Test Methods Section, Method F-16 TEST METHOD FOR THE FLAME RESISTANCE OF TENTS			Amendment number- Numéro de la modification 26

5.3.3.5 The black panel temperature at the exposure plane of the specimen rack shall be $155^{\circ} \pm 10^{\circ}\text{F}$. ($68^{\circ} \pm 5.7^{\circ}\text{C}$.) when measured in the following manner:

Before reading the temperature the machine shall be full of specimens and shall be in operation long enough for thermal equilibrium to be established. The black panel shall be mounted in the test-panel rack and readings taken at the point where water spray is not striking the panel.

5.3.3.6 The specimen shall be suspended on the rotating rack without tension and in such a way that the ends or corners cannot curl. The long dimension of the specimen shall be in the vertical position and shall be indicated on the reverse side of the cloth. No test portion of the specimen shall be over 7 inches above or below the horizontal plane of the arc.

5.3.3.7 The specimen shall be exposed to normal radiation from the arc for 100 hours.

5.3.3.8 At the end of the exposure period, the specimen shall be removed from the machine, allowed to dry, and brought to Standard Atmospheric Conditions prior to further testing.

6. Test Method, Flooring Material

6.1 Test Specimen. Each test specimen shall be a 9 inch by 9 inch ($\pm 1/16$ inch) section of the flooring material to be tested.

6.2 Apparatus

6.2.1 Test Chamber. The test chamber shall consist of an open top hollow cube made of noncombustible material with inside dimensions 12 x 12 x 12 inches and a minimum of 1/4 inch wall thickness. The flat bottom of the box shall be made of the same material as the sides and shall be easily removable. The sides shall be fastened together with screws or brackets and taped to prevent air leakage into the box during use.

6.2.2 Supporting Frame. A steel plate, 9 inches by 9 inches, 1/4 inch thick with an 8 inch diameter hole in its center and a 1 inch by 1 inch by 1/16 inch thick shim affixed to the underside of each corner is required to support the material above the floor of the chamber during the course of the test. The edge of the supporting frame must be kept clean.

6.2.3 Flattening Frame. A steel plate 9 inches by 9 inches, 1/4 inch thick with an 8 inch diameter hole in its center is required to hold the flooring material flat during the course of the test.

6.2.4 Punch. A punch capable of making a 1/4 inch diameter hole in the center of the specimen of flooring material to be tested.

6.2.5 Standard Igniting Source. No. 1588 methenamine timed burning tablet or an equal tablet. These tablets shall be stored in a desiccator over a desiccant for 24 hours prior to use. (Small quantities of sorbed water may cause the tablets to fracture when first ignited. If a major fracture occurs, any results from the test shall be ignored, and it shall be repeated.)

6.2.6 Hood: A hood capable of being closed and having its draft turned off during each test and capable of rapidly removing the products of combustion following each test. The front or sides of the hood should be transparent to permit observation of the tests in progress.

 Health Santé Canada Canada	Title of publication-Titre de la publication Product Safety Laboratory Reference Manual Book 5 - Laboratory Policies and Procedures	Page F16-16	Effective En vigueur 2001-04-24
Chapter and/or Section;-Number and title-Chapitre ou section-Numéro et titre Part B: Test Methods Section, Method F-16 TEST METHOD FOR THE FLAME RESISTANCE OF TENTS			Amendment number- Numéro de la modification 26

6.2.7 Mirror: A small mirror mounted above the test chamber at an angle to permit observation of the specimen from outside of the hood.

6.3 Procedure

6.3.1 Place the test chamber in the draft-protected environment (hood with draft off) with its bottom in place and the supporting frame centered in the bottom of the chamber, shimmed side down.

6.3.2 Punch a 1/4 inch diameter hole in the center of the specimen of flooring material to be tested.

6.3.3 Place the specimen on the supporting frame in the position in which it will be used, exercising care that the specimen is horizontal and flat. Place the flattening frame on the specimen and position a methenamine tablet on one of its flat sides with its edge within 1/8 inch of the hole in the center of the specimen.

6.3.4 Ignite the tablet by touching a lighted match or an equivalent igniting source carefully to its top.

6.3.5 Continue each test until the last vestige of flame or glow disappears (this is frequently accompanied by a final puff of smoke) or the flaming or smoldering has approached within 1.0 inch of the edge of the hole in the flattening frame at any point. (Any test in which the tablet is extinguished by physical action of the specimen of flooring material shall be disregarded and the test repeated.)

6.3.6 When all combustion has ceased, ventilate the hood and measure the shortest distance between the edge of the hole in the flattening frame and the damaged area. Record the distance measured for each specimen.

6.3.7 Remove the specimen from the chamber and remove any burn residue from the floor of the chamber. Before proceeding to the next test, the floor must be cooled to normal room temperature or replaced with one that is at normal room temperature.

6.4 Report. The number of specimens of the four tested in which the damaged area does not extend to within 1.0 inch of the edge of the hole in the flattening frame shall be reported.

6.5 Notes

6.5.1 The No. 1588 methenamine tablet may be procured from a local pharmacy or from Eli Lilly & Co., 740 S. Alabama, Indianapolis, Indiana 46206.

7. Test Method, Wall and Top Material

7.1 Test Specimen. The test specimens shall be rectangles of cloth 2 3/4 inches by 12 inches (+ 1/16 inch) with the long dimensions parallel to either the warp or filling directions of the material.

7.2 Apparatus

7.2.1 Cabinet: A cabinet and accessories, fabricated in accordance with the requirements specified in Figures A, B and C. Galvanized sheet metal or other suitable metal shall be used. The entire inside back wall of the cabinet shall be painted black to facilitate the viewing of the test specimen and pilot flame.

 Health Santé Canada Canada	Title of publication-Titre de la publication Product Safety Laboratory Reference Manual Book 5 - Laboratory Policies and Procedures	Page F16-17	Effective En vigueur 2001-04-24
Chapter and/or Section;-Number and title-Chapitre ou section-Numéro et titre Part B: Test Methods Section, Method F-16 TEST METHOD FOR THE FLAME RESISTANCE OF TENTS			Amendment number- Numéro de la modification 26

7.2.2 Burner The burner shall be equipped with a variable orifice to adjust the flame height, a barrel having a 3/8 inch inside diameter, and a pilot light.

7.2.2.1 The burner may be constructed by combining a 3/8 inch inside diameter barrel 3 ± 1/4 inches long from a fixed orifice burner with a base from a variable orifice burner.

7.2.2.2 The pilot light tube shall have a diameter of approximately 1/16 inch and shall be spaced 1/8 inch away from the burner edge with a pilot flame 1/8 inch long.

7.2.2.3 The necessary gas connections and the applicable plumbing shall be as specified in Figure D except that a solenoid valve may be used in lieu of the stopcock valve to which the burner is attached. The stopcock valve or solenoid valve, whichever is used, shall be capable of being fully opened or fully closed in 0.1 second.

7.2.2.4 On the side of the barrel of the burner, opposite the pilot light there shall be a metal rod of approximately 1/8 inch diameter spaced 1/2 inch from the barrel and extending above the burner. The rod shall have two 5/16 inch prongs marking the distances of 3/4 inch and 1 1/2 inches above the top of the burner.

7.2.2.5 The burner shall be fixed in a position so that the center of the barrel of the burner is directly below the center of the specimen.

7.2.3 A control valve system with a delivery rate designed to furnish gas to the burner under a pressure of 2 1/2 ± 1/4 lbs. per square inch at the burner inlet (see 7.5.1). The manufacturer's recommended delivery rate for the valve system shall include the required pressure.

7.2.4 The gas used shall be Matheson Manufactured Gas Type B or the equivalent.

7.2.5 Metal hooks and weights to produce a series of total loads to determine damaged length. The metal hooks shall consist of No. 19 gauge steel wire or equivalent and shall be made from 3 inch lengths of the wire and bent 1/2 inch from one end to a 45 degree hook. One end of the hook shall be fastened around the neck of the weight to be used.

7.2.6 Stop watch or other device to measure the burning time to 0.2 second.

7.2.7 Scale, graduated in 0.1 inch to measure the damaged length.

7.2.8 Clamps For holding the specimen to the supporting frame shall be Acco #325, Hunt Bulldog Clips No.2, or equivalent. A total of four clamps, two on each side are used. Two clamps 3/4 inch above the bottom edge and two clamps 1 1/2 inch above the first two.

7.3 Procedure

7.3.1 The specimen in its holder shall be suspended vertically in the cabinet in such a manner that the entire length of the specimen is exposed and the lower end is 3/4 inch above the top of the gas burner. The apparatus shall be set up in a draft free area.

 Health Santé Canada Canada	Title of publication-Titre de la publication Product Safety Laboratory Reference Manual Book 5 - Laboratory Policies and Procedures	Page F16-18	Effective En vigueur 2001-04-24
Chapter and/or Section;-Number and title-Chapitre ou section-Numéro et titre Part B: Test Methods Section, Method F-16 TEST METHOD FOR THE FLAME RESISTANCE OF TENTS			Amendment number- Numéro de la modification 26

7.3.2 Prior to inserting the specimen, the pilot flame shall be adjusted to approximately 1/8 inch in height measured from its lowest point to the tip. The burner flame shall be adjusted by means of the needle valve in the base of the burner to give a flame height of 1 1/2 inches (+ 1/16 inch) with the stopcock fully open and the air supply to the burner shut off and taped. The 1 1/2 inch flame height is obtained by adjusting the valve so that the uppermost portion (tip) of the flame is level with the tip of the metal prong (see Figure B) specified for adjustment of flame height. It is an important aspect of the evaluation that the flame height be adjusted with the tip of the flame level with the tip of the metal prong. After inserting the specimen, the stopcock shall be fully opened, and the burner flame applied vertically at the middle of the lower edge of the specimen for 12 seconds (+ .2 second) and the burner turned off. The cabinet door shall remain shut during testing.

7.3.3 The after-flame time for each specimen shall be recorded to the nearest 0.2 seconds. After flaming and glowing have ceased, the specimen shall be removed from the cabinet.

7.3.4 After each specimen is removed, the test cabinet shall be cleared of fumes and smoke prior to testing the next specimen.

7.3.5 After both flaming and glowing have ceased, the damaged length shall be measured. The damaged length shall be the distance from the end of the specimen, which was exposed to the flame, to the end of a tear (made lengthwise) of the specimen through the center of the damaged area as follows: The specimen shall be folded lengthwise and creased by hand along a line through the highest peak of the damaged area. The hook shall be inserted in the specimen (or a hole, 1/4 inch diameter or less, punched out for the hook) at one side of the damaged area 1/4 inch from the adjacent outside edge and 1/4 inch in from the lower end. A weight of sufficient size such that the weight and hook together shall equal the total tearing load required in 7.3.6.1 shall be attached to the specimen.

7.3.6 A tearing force shall be applied gently to the specimen by grasping the corner of the cloth at the opposite edge of the char from the load and raising the specimen and weight clear of the supporting surface. The end of the tear shall be marked off on the edge and the damaged length measurement made along the undamaged edge.

7.3.6.1 Loads for Determining Damaged Length. The specific load applicable to the weight of the test material shall be as follows:

Untreated Weight of Material Being Tested - Ounces per Square Yard	Total Tear Weight for Determining the Damaged Length - Pounds
Not exceeding 3.0	0.125
Over 3.0 and not exceeding 6.0	0.25
Over 6.0 and not exceeding 10.0	0.50
Over 10.0	0.75

7.3.7 The damaged length for each specimen shall be recorded to the nearest 0.1 inch.

 Health Santé Canada Canada	Title of publication-Titre de la publication Product Safety Laboratory Reference Manual Book 5 - Laboratory Policies and Procedures	Page F16-19	Effective En vigueur 2001-04-24
Chapter and/or Section;-Number and title-Chapitre ou section-Numéro et titre Part B: Test Methods Section, Method F-16 TEST METHOD FOR THE FLAME RESISTANCE OF TENTS			Amendment number- Numéro de la modification 26

7.4 Report

7.4.1 The after-flame time and damaged length of the sample unit shall be the average of the results obtained from the individual specimens tested. All values obtained from the individual specimens shall be recorded.

7.4.2 The after-flame time shall be reported to the nearest 0.2 second and the damaged length to the nearest 0.1 inch.

7.5 Notes

7.5.1 The gas and the regulator valve system, Models IL-350 and 70 with hose and fittings connected in series may be obtained from Matheson Gas Products, P. O. Box 85, East Rutherford, New Jersey 07073.

7.5.2 The test cabinet of the type described in this test method may be obtained from U. S. Testing Company, 1941 Park Avenue, Hoboken, New Jersey, 07030 or from the Govmark Organization, Inc., P. O. Box 807, Bellmore, New York 11710.

Chapter and/or Section;-Number and title-Chapitre ou section-Numéro et titre

Part B: Test Methods Section, Method F-16
TEST METHOD FOR THE FLAME RESISTANCE OF TENTS

Amendment
number-
Numéro de la
modification

26

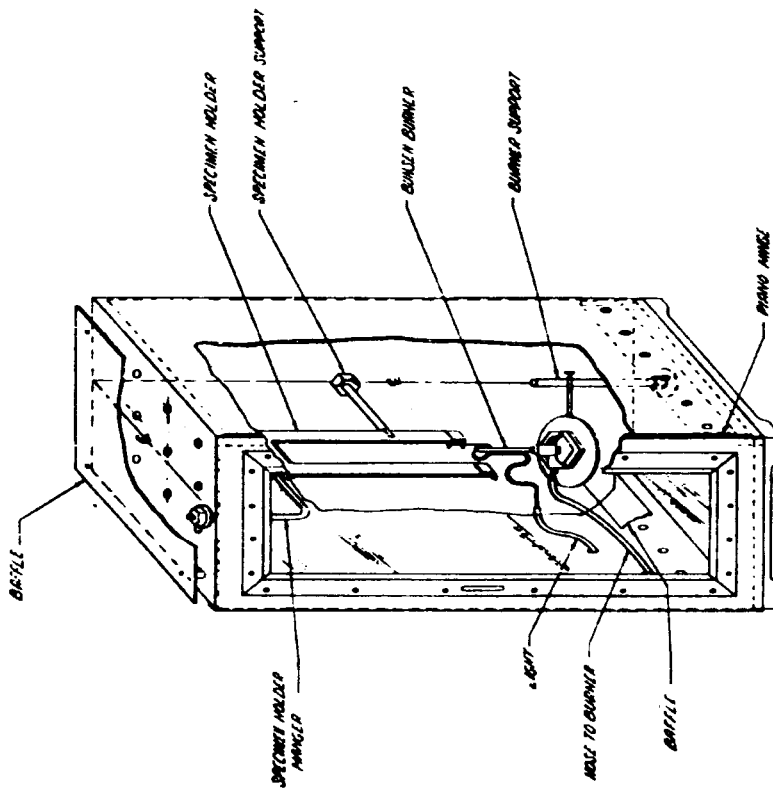

ILLUSTRATION

FIGURE A - Vertical flame resistance textile apparatus.